

# SWIMMING POOL PUMPS



[WWW.DABPUMPS.US](http://WWW.DABPUMPS.US)







## DAB AND SWIMMING POOLS



With **over 2 million items produced every year**, **DAB** electric pumps are synonymous with technology and reliability. Established in 1975, **DAB PUMPS** is today **an international point of reference in the water systems market**. The careful selection of materials and the approval procedures applied to each line before production release, ensure both product **reliability and maximum performance levels**.

During the last few years DAB has invested resources, passion and energy, acquiring companies with different specific skills, from electronics to motors. All this has allowed us to present ourselves as a solid partner capable of offering **solutions designed and created entirely in Italy** that can meet the needs of modern technical engineering.

## WHY CHOOSE DAB'S SWIMMING POOL SOLUTIONS



**DAB's pumps for swimming pools** are developed to guarantee reliability, efficiency and ease of maintenance. Designed to offer added value for the installer and considerable savings, as well as comfort for the end user. The pumps are suitable for all types of applications, from above ground & in-ground residential swimming pools to public swimming pools.

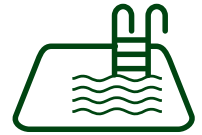

### ELECTRONIC CENTRIFUGAL PUMPS



The pump is the beating heart of the swimming pool since it moves the water for the purpose of filtration and treatment. A conventional pump, however, can be extremely expensive as it consumes more power than all the other appliances combined. For this reason, **DAB** designed the highly energy-efficient **E.SWIM** electronic pump with low-consumption variable speed motor and hydraulics far superior to those of single-speed pumps.

**E.SWIM** is the ideal solution for reducing energy costs: it requires up to 90% less power than a conventional pump at constant speed.



Energy saving up to 90% to any other traditional solution



Extreme reliability, with components designed for long life



High efficiency, thanks to the new brushless motor, new hydraulics, new electronic board

MODEL	Q at 10 m	Q at 30 ft
E.SWIM 150	24 m <sup>3</sup> /h	107 gpm
E.SWIM 300	37 m <sup>3</sup> /h	163 gpm

**E.SWIM 150**  
Max  
**132 gpm (30 m<sup>3</sup>/h)**  
**52 ft (16 m)**

**E.SWIM 300**  
Max  
**187 gpm (42 m<sup>3</sup>/h)**  
**85 ft (26 m)**

**NEW**



### e.pro

Version with two knobs locking system.

#### AWARDS AND CERTIFICATIONS

Award received at MCE 2016

Percorso **Efficienza** **Innovazione**  
oltre la **classe A** 2016



# OVERVIEW

## LOW NOISE

### NO VIBRATIONS

The innovative water cooled motor, the inverter, the sound absorbing hulls, and the anti-vibration legs make e.swim the most silent swimming pool pumps on the market.

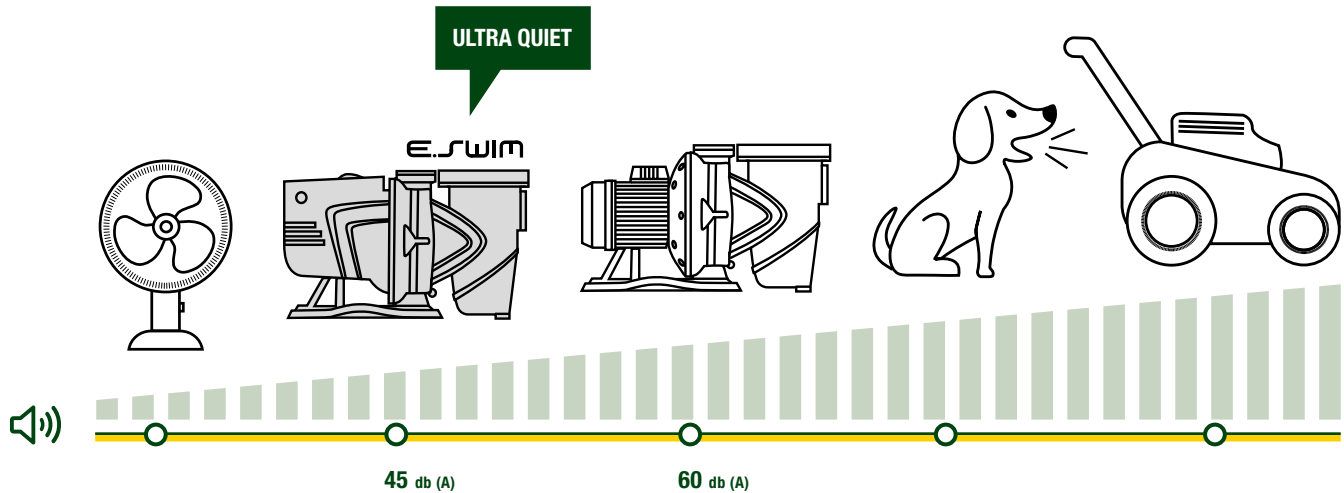

## EXTREMELY COMPACT

The new structure and ergonomic design make for a compact product that can be installed anywhere. It occupies 30% less space than any other conventional system.

## MINIMUM SPACE REQUIREMENT

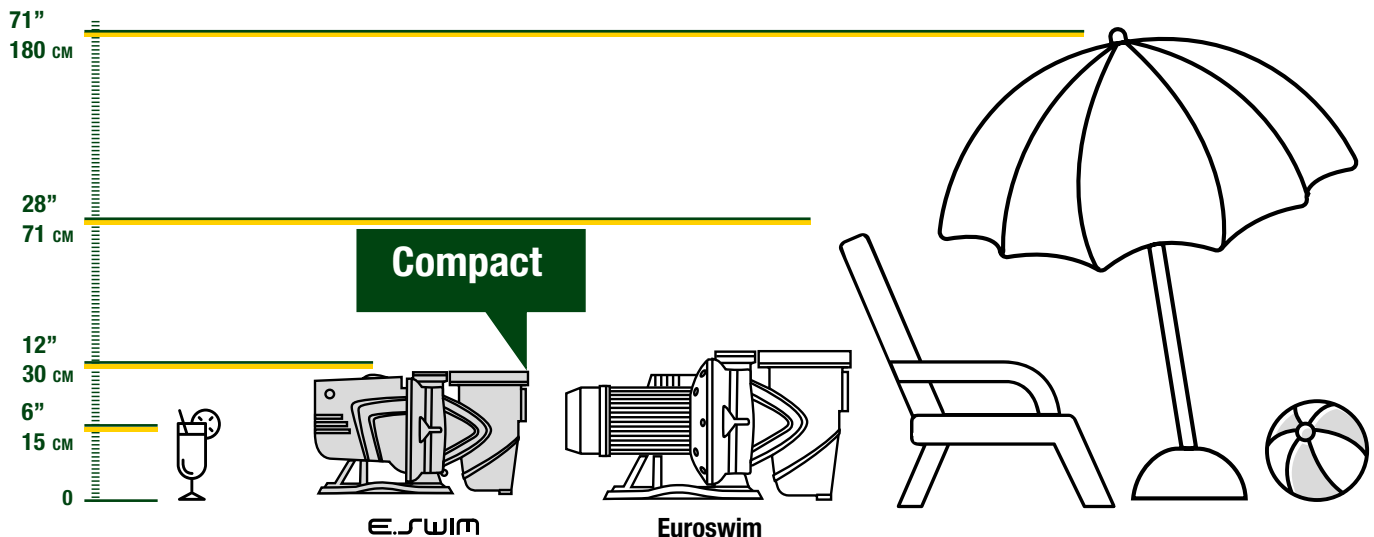

## TECNICAL DATA

	P1 MAX	Q MAX	H MAX	DIMENSIONS
<b>E.SWIM 150</b>	<b>1.5Hp - 1250 W</b>	<b>132gpm - 30 m<sup>3</sup>/h</b>	<b>52 ft - 16 m</b>	<b>21.6" x 11.8" x 12.2"</b> 550 x 300 x 316 cm
<b>E.SWIM 300</b>	<b>3.0Hp - 2250 W</b>	<b>187gpm - 42 m<sup>3</sup>/h</b>	<b>85 ft - 26 m</b>	<b>22.6" x 11.9" x 13.9"</b> 574 x 304 x 354 cm

# OVERVIEW

**UP TO 90%  
ENERGY  
SAVINGS  
COMPARED TO  
ANY CONVENTIONAL  
SOLUTION**

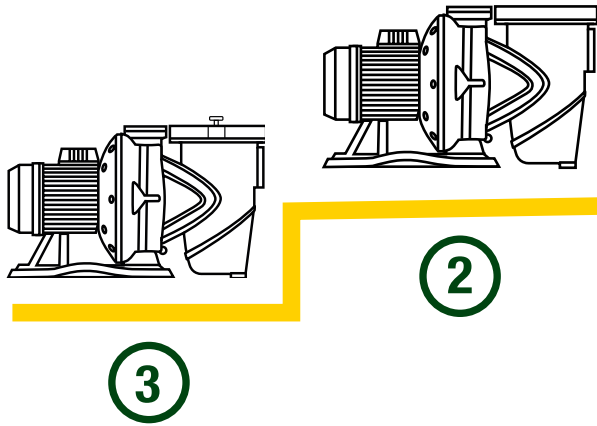

# ENERGY SAVING

A LINE WORTHY OF AN OLYMPIC MEDAL

Guarantees the comforts and savings of constant pressure in the system thanks to :

- High efficiency brushless motor
- Optimised hydraulics to reduce pressure losses
- 8 settable speeds

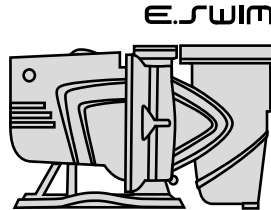

# DISPLAY

LCD 2 3/4" x 1 1/2" (70X40 mm) HD screen. The intuitive interface gives access to all the system information and the main settings depending on the specific application.

USER FRIENDLY INTERFACE

PARAMETER MONITORING

HD LCD DISPLAY



**MANUAL**



Preset set point configurable with a specific time from the panel UI.

**AUTO**

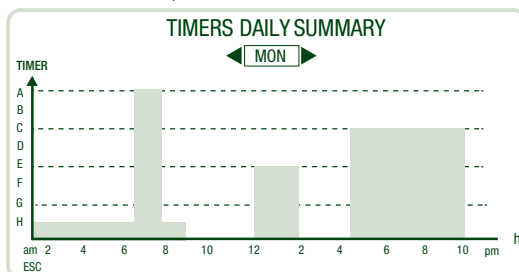

Setable with automatic time setting daily and weekly at various speeds.

Can be connected to a digital or analog REMOTE pump control (4-20mA / 0-10V)





# FEATURES



## DESIGN

This innovative solution combines aesthetics with sturdy materials highly resistant to corrosion and oxidation.



## INTEGRATED PREFILTER

It has a large canister, a cover that can be removed without tools, and an internal filter easy to take out and clean.

# SALT WATER COMPATIBLE



## VARIABLE SPEED CONTROL

The inverter control board permits operation at variable speed or flow rate, optimising performance and reducing consumption without the need for sensors.



## SYNCHRONOUS MOTOR WITH PERMANENT MAGNETS

The new synchronous motor with permanent magnets represents a new benchmark on the market due to its efficiency and dependability.



## HIGH EFFICIENCY HYDRAULICS

The impeller and volute are designed specifically to improve/optimise hydraulic performance.



## WATER COOLING

Motor cooled by the pumped water, free from fan cooling. It gains in compactness and low noise.



## ANTI-VIBRATION FEET

The supporting base guarantees stability with integrated rubber feet that reduce vibrations.



## USER INTERFACE PANEL

User friendly interface with HD LCD display for programming and monitoring working parameters.



# E.SWIM



### CENTRIFUGAL PUMPS

Self-priming centrifugal high performance electric pumps with incorporated high capacity pre-filter. Completely watertight motor. Extremely silent and highly reliable, developed for the circulation and filtration of water in domestic and residential swimming pools.



Easy-to-install and maintain

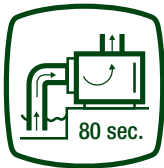

Self priming up to 6 ft (2m)



Corrosion resistant materials



### EUROPRO

Version with two knobs locking system.



MODEL	Q at 10 m	Q at 30 ft
EUROSWIM 50	11 m <sup>3</sup> /h	53 gpm
EUROSWIM 75	14 m <sup>3</sup> /h	66 gpm
EUROSWIM 100	16 m <sup>3</sup> /h	88 gpm
EUROSWIM 150	23 m <sup>3</sup> /h	110 gpm
EUROSWIM 200	30 m <sup>3</sup> /h	132 gpm
EUROSWIM 300	38 m <sup>3</sup> /h	180 gpm

#### CERTIFICATIONS





# FEATURES



## DESIGN

This innovative solution combines aesthetics with sturdy materials with a high resistant to corrosion and oxidation.



## TERMINAL BOARD BOX

Easy and fast line connection, It is totally closed against electrical motor to avoid any accidentally solid bodies entry



## INTEGRATED PREFILTER

It has a large canister, a cover that can be removed without tools, and an internal filter easy to take out and clean.

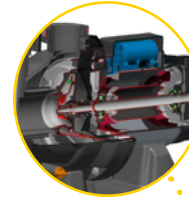

## MOTOR

All metallic components have a special surface treatment  
Suitable for working at high temperature situation up to 122°F (50°C)  
With condensate drain holes  
The capacitor is housed inside the terminal board box  
Water proof bearings



## ANTI-VIBRATION FEET

The base support guarantees stability with its integrated rubber feet that reduce any vibrations.



## HYDRAULIC COMPONENTS

All components in contact with the liquid are made in polypropylene or noryl with glass fiber  
The high efficiency Impeller has a special design to cover and protect motor shaft against corrosion (motor is completely insulated)

**SALT WATER**  
**COMPATIBLE**

**Euroswim**

# SELECTION TABLE

## RESIDENTIAL SWIMMING POOL

	DIMENSIONS OF POOL	VOLUME OF WATER	FLOW	MODEL		
	(ft)	(gal)	(gpm)	@ 30 & 40 ft Head	@ 30 ft Head	@ 40 ft Head
PRIVATE SWIMMING POOL	10 x 20	7500	15.63	E.SWIM 150	EUROSWIM 50	EUROSWIM 75
	12 x 24	10800	22.50	E.SWIM 150	EUROSWIM 50	EUROSWIM 75
	15 x 30 x 5	16875	35.16	E.SWIM 150	EUROSWIM 50	EUROSWIM 75
	18 x 36 x 5	24300	50.63	E.SWIM 150	EUROSWIM 75	EUROSWIM 100
	20 x 40 x 5	30000	62.50	E.SWIM 150	EUROSWIM 100	EUROSWIM 150
PUBLIC SWIMMING POOL	10 x 20	7500	25.00	E.SWIM 150	EUROSWIM 50	EUROSWIM 75
	12 x 24	10800	36.00	E.SWIM 150	EUROSWIM 50	EUROSWIM 75
	15 x 30 x 5	16875	56.25	E.SWIM 150	EUROSWIM 75	EUROSWIM 100
	18 x 36 x 5	24300	81.00	E.SWIM 150	EUROSWIM 150	EUROSWIM 150
	20 x 40 x 5	30000	100.00	E.SWIM 300	EUROSWIM 200	EUROSWIM 200
	30 x 40 x 5	45000	150.00	E.SWIM 300	EUROSWIM 300	EUROSWIM 300

\*Times for complete recirculation of water within 8 hours for private pool and 5 hours for public pool

### E.SWIM 150

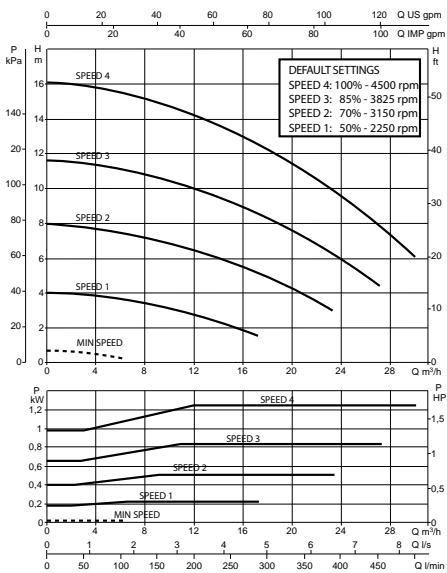

### E.SWIM 300

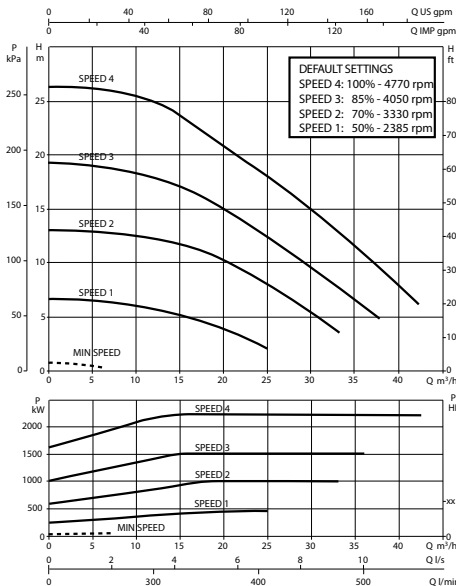

### Euroswim

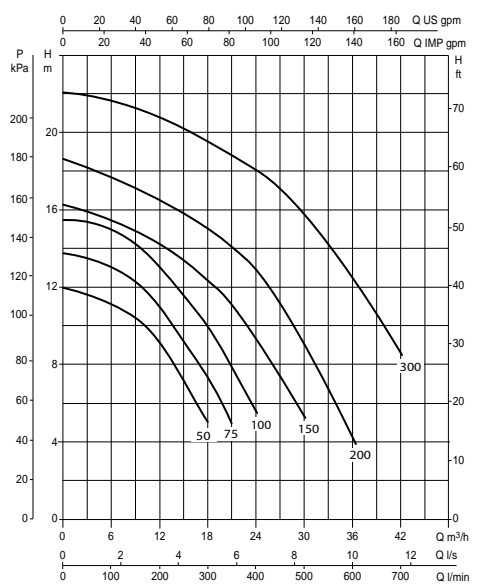



# COMPARISON TABLE



E-SWIM



Euroswim

FEATURES	E-SWIM	Euroswim
HIGH EFFICIENCY HYDRAULICS		✓
HIGHLY RELIABLE AND DURABLE COMPONENTS	✓	✓
SMALL SIZE, FOR EASE OF INSTALLATION		✓
LCD DISPLAY	✓	✗
8 SPEEDS THAT CAN BE SET WITH TIMER	✓	✗
INTEGRATED DIAGNOSTICS FOR PROTECTION OF THE PUMP	✓	✗
DAB CONNECTIVITY	✓	✗
OPERATION AT VARIABLE SPEED	✓	✗
OPERATION AT VARIABLE FLOW RATE	✓	✗
OPERATION AT CONSTANT FLOW RATE	✓	✗
HIGH EFFICIENCY “BRUSHLESS” MOTORS WITH PERMANENT MAGNETS	✓	✗
WATER COOLING WITHOUT NEED FOR FAN	✓	✗
BACKWASHING MODE	✓	✗

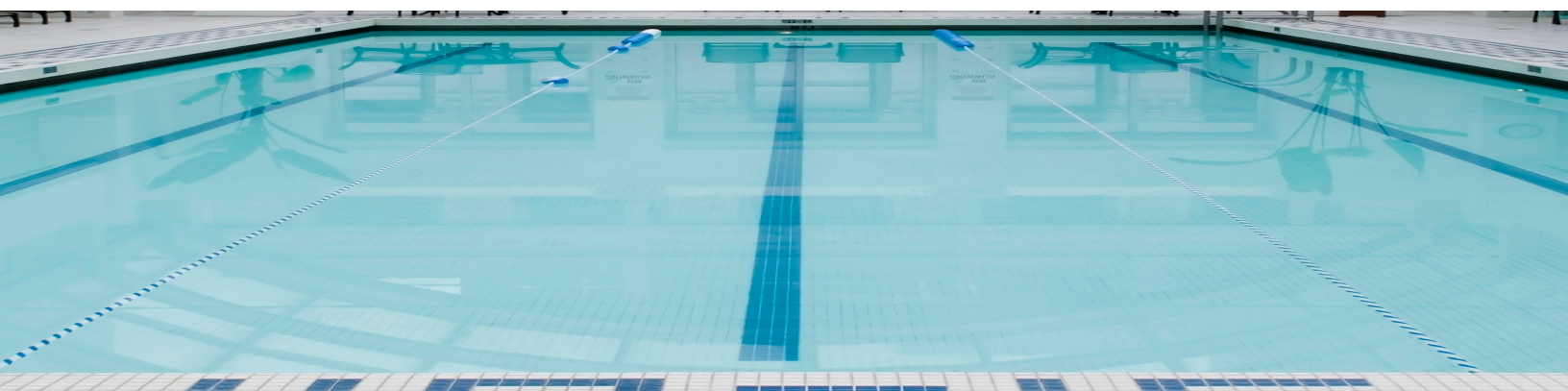



## A WIDE RANGE

# EUROPRO HIGH FLOW

### SWIMMING POOL LARGE FILTRATION

Self-priming, high-performance centrifugal pumps, with built-in large capacity prefilter. 2 or 4 pole motor completely isolated from the water. Extremely quiet and highly reliable, developed for the circulation and filtration in large swimming pool filtration systems. Also suitable for particular applications that require handling of seawater thanks to the mechanical seal made of AISI 316.



**SALT WATER  
COMPATIBLE**



# NKM-G / NKP G

### SWIMMING POOL LARGE FILTRATION

The new range of prefilters gives the possibility of using the standardised monobloc centrifugal pumps of the NKM-G/NKP-G ranges, starting from DN 40 up to DN 150, for the circulation of water in large filtration systems



**A WIDE RANGE**

# JETCOM SP - EUROCOM SP

## SWIMMING POOL WATER SUPPLY

The JETCOM SP is a single impeller jet pump with excellent self priming capabilities. The EUROCOM SP is horizontal axis multistage centrifugal pump, characterised by extremely quiet operation. Both pumps are ideal for cleaning swimming pools and all applications involving the circulation of aggressive water in general containing chlorine.

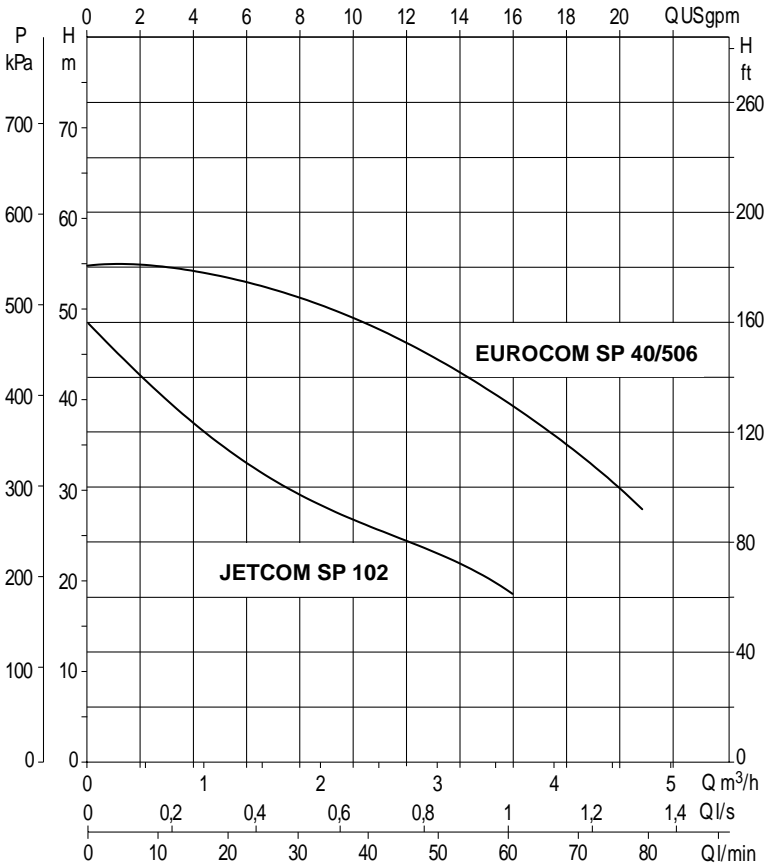

**SALT WATER  
COMPATIBLE**



# UTILITY PUMP

Utility pumps are multi-purpose pumps. Uses range from everyday applications around your swimming pool. Typical applications include, draining clear and waste water , salt water and to create water features.

## NOVA UP MNA



Submersible pumps in technopolymer ideal for draining in residential environments subject to flooding or for portable applications such as emptying swimming pools, fountains and small excavations.

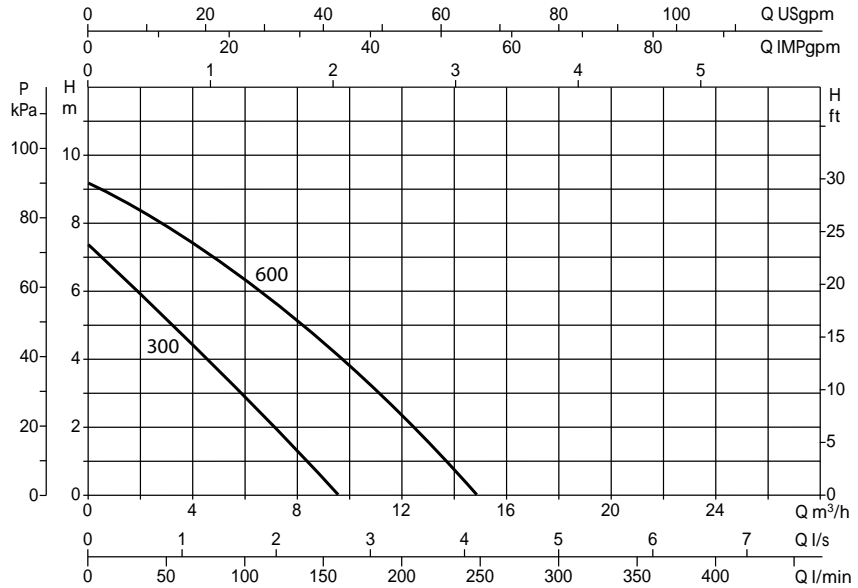

Submersible pumps ideal for draining and emptying in the residential sector. Suitable for pumping dirty water with solid particle size up to 1 1/2" (50 mm).

## FEKA BVP

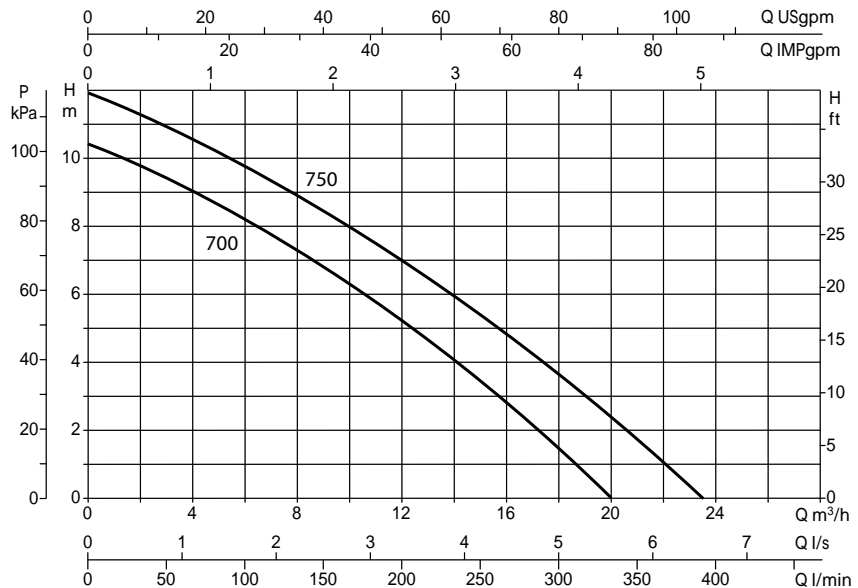







# DAB Pumps Inc.

3226 Benchmark Dr.

Ladson, SC 29456

Tel 843 797 5002

Fax 843 797 3366

email [info.usa@dwtgroup.com](mailto:info.usa@dwtgroup.com)

Web [www.dabpumps.us](http://www.dabpumps.us)



#### DAB PUMPS LTD.

6 Gilberd Court  
Newcomen Way  
Severalls Business Park  
Colchester  
Essex  
CO4 9WN - UK  
[salesuk@dwtgroup.com](mailto:salesuk@dwtgroup.com)  
Tel. +44 0333 777 5010



#### DAB PUMPS B.V.

B'Hofveld 6 C1  
1702 Groot Bijgaarden - Belgium  
[info.belgium@dwtgroup.com](mailto:info.belgium@dwtgroup.com)  
Tel. +32 2 4668353



#### DAB PUMPS B.V.

Albert Einsteinweg, 4  
5151 DL Drunen - Nederland  
[info.netherlands@dwtgroup.com](mailto:info.netherlands@dwtgroup.com)  
Tel. +31 416 387280  
Fax +31 416 387299



#### DAB PUMPEN DEUTSCHLAND GmbH

Tackweg 11  
D - 47918 Tönisvorst - Germany  
[info.germany@dwtgroup.com](mailto:info.germany@dwtgroup.com)  
Tel. +49 2151 82136-0  
Fax +49 2151 82136-36



#### DAB PUMPS IBERICA S.L.

Calle Verano 18-20-22  
28850 - Torrejón de Ardoz - Madrid Spain  
[info.spain@dwtgroup.com](mailto:info.spain@dwtgroup.com)  
Tel. +34 91 6569545  
Fax: +34 91 6569676



#### DAB PRODUCTION HUNGARY KFT.

H-8800  
Nagykanizsa, Buda Ernó u.5  
Hungary  
Tel. +36 93501700



#### DAB PUMPS POLAND Sp. z o.o.

Mokotów Marynarska  
ul. Postępu 15C  
02-676 Warszawa - Poland  
[polska@dabpumps.com.pl](mailto:polska@dabpumps.com.pl)  
Tel. +48 223 816 085



#### DAB UKRAINE Representative Office

Regus Horizon Park  
4 M. Hrinchenka St, suit 147  
03680 Kiev - Ukraine  
Tel. +38 044 391 59 43



#### OOO DAB PUMPS

Novgorodskaya str. 1, block G  
office 308, 127247, Moscow - Russia  
[info.russia@dwtgroup.com](mailto:info.russia@dwtgroup.com)  
Tel. +7 495 122 0035  
Fax +7 495 122 0036



#### DAB PUMPS INC.

3226 Benchmark Drive  
Ladson, SC 29456 - USA  
[info.usa@dwtgroup.com](mailto:info.usa@dwtgroup.com)  
Tel. 1-843-797-5002  
Fax 1-843-797-3366



#### DWT SOUTH AFRICA

wenty One industrial Estate,  
16 Purlin Street, Unit B, Warehouse 4  
Olifantsfontein -1666 - South Africa  
[info.sa@dwtgroup.com](mailto:info.sa@dwtgroup.com)  
Tel. +27 12 361 3997



#### DAB PUMPS CHINA

No.40 Kaituo Road, Qingdao Economic & Technological  
Development Zone  
Qingdao City, Shandong Province - China  
PC: 266500  
[info.china@dwtgroup.com](mailto:info.china@dwtgroup.com)  
Tel. +8653286812030-6270  
Fax +8653286812210



#### DAB PUMPS DE MÉXICO, S.A. DE C.V.

Av Amsterdam 101 Local 4  
Col. Hipódromo Condesa,  
Del. Cuauhtémoc CP 06170  
Ciudad de México  
Tel. +52 55 6719 0493



#### DAB PUMPS OCEANIA PTY LTD

426 South Gippsland Hwy,  
Dandenong South VIC 3175 - Australia  
[info.oceania@dwtgroup.com](mailto:info.oceania@dwtgroup.com)  
Tel. +61 1300 378 677



Via Marco Polo, 14 - 35035 Mestrino (PD) Italy - Phone +39.049.5125000 - Fax +39.049.5125950

[www.dabpumps.com](http://www.dabpumps.com)